

LIMBACH

Flugmotoren

Operating and Maintenance Manual

Limbach L 1700

**Engine for Powered Gliders and
Very Light Aircraft**

Edition: 20.08.2021

The technical content of this document is approved under the Authority of EASA ref. approval number 10077418 and have been produced in accordance with alternative procedure to DOA nr. EASA.AP509.

Approval and translation has been done by best knowledge and judgement. - In any case the original text (P/N 170.253.900.000) in german language is authoritative.

Limbach Flugmotoren GmbH
Kotthausener Str. 5
53639 Königswinter, Germany
Tel. ++49-2244-9201-0
Fax ++49-2244-9201-30
www.limflug.de

Table of Contents

1.1	Change Index	4
1.2	Release	4
2	Introduction	5
3	Engine Description	6
3.1	Model Designation	6
3.2	Cylinder Designation	8
4	Technical Data	9
4.1	LIMBACH L 1700 E0	9
4.2	LIMBACH L 1700 EA	11
4.3	LIMBACH L 1700 EB	13
4.4	LIMBACH L 1700 EC	15
4.5	LIMBACH L 1700 ED	16
5	Performance	18
5.1	Performance Graph LIMBACH L 1700 E0 and L 1700 EC	18
5.2	Performance Graph LIMBACH L 1700 EA	19
5.3	Performance Graph LIMBACH L 1700 EB	20
5.4	Performance Graph LIMBACH L 1700 ED	21
6	Operating Instructions	22
6.1	Before Starting	22
6.2	Engine Start-Up	22
6.3	Runup, Performance Check	23
6.3.1	Performance Check	23
6.3.2	Check carburetor heating for proper functioning	23
6.4	Hot Engine Start-Up	23
6.5	Take-Off	23
6.6	Engine Shut-Down	24
6.7	Inflight Shut-Down and Restarting	24
6.8	Engine operation on hot days	24
7	Maintenance Schedule	25
7.1	Daily Check	25
7.2	Periodical Checks	25
7.2.1	Every 6 Months Following 100 h Inspection	25
7.2.2	Every 2 Years	25
7.2.3	Every 4 Years	25
7.2.4	Every 5 Years after engine manufacture or major overhaul	25
7.2.5	Every 12 Years	25
7.3	Operating Time related Inspections	26
7.3.1	After the first 5 Operating hours	26
7.3.2	After the first 25 Operating hours	26
7.3.3	Every 25 Operating hours	26
7.3.4	Every 50 Operating hours	26
7.3.5	Every 100 Operating hours	27
7.3.6	Every 250 Operating hours	27
7.3.7	Every 500 Operating hours	27
7.4	Unscheduled replacement of components	27
8	Maintenance Instructions	28
8.1	Oil Change	28
8.2	Cleaning of Air Filter	29
8.3	Check and greasing of Carburetor control	29
8.4	Replacing of Float Valve	29
8.5	Check / replacement of Carburetor Diaphragm	29
8.6	Carburetor Oil level check	30
8.7	Fuel Pump Screen cleaning	30
8.7.1	Engines with APG Fuel Pump	30
8.7.2	Engines with Limbach Fuel Pump	31
8.8	Fuel Filter cleaning	32
8.9	Fuel and Lubrication System leakage check	32
8.10	Crankcase Ventilation Check	32
8.11	Compression Check	32

170.253.905.000

8.12	Check and Setting of Valve Clearance	32
8.13	Check valve shaft projection length for intake and exhaust valves	33
8.14	Cleaning, Check and Setting of Spark Plugs	34
8.15	Drive Belt check, stretching and replacement	35
8.16	Exhaust System Check	36
8.17	Bowden Cable Check	36
8.18	Harness Check	36
8.19	Check of Bolted Connections	36
8.20	Engine Test Run	37
8.21	Engine Preservation	37
8.21.1	Compliance	37
8.22	Operation at low ambient Temperatures	38
8.23	Operation in Tropical Conditions	39
8.24	Miscellaneous	39
9	Overhaul	40
9.1	Major Overhaul	40
9.2	Major Repair	40
10	Lubricants, Coolants, Fuels	41
10.1	List of Lubricants	41
10.2	Fuels	42
11	Recommended Tightening Torques	43
12	Trouble Shooting	44
12.1	Engine Starting Trouble	44
12.2	Engine Operating Trouble	45
12.2.1	Fuel Supply	45
12.2.2	Ignition	46
12.2.3	Cooling	47
12.2.4	Lubrication	47
12.3	Mechanical System	48

1.1 Change Index

This Edition replaces the Operating and Maintenance Manual from 01.03.2016.

This manual has 48 pages and is issued per 20.08.2021.

This edition replaces:

Date	Description
07/92	New edition
01.03.2016	Replaces edition from 07/92
20.08.2021	Replaces edition from 01.03.2016

1.2 Release

Released and approved on: 20.08.2021

B.Eng. Sven Simmerkuss

2 Introduction

This manual is meant to instruction for proper operation and maintenance of the aircraft engine.

Modifications to the engine are only permitted with the approval of our development department.



Caution:

The specially identifies safety notes must be observed to prevent accidents with personal injuries and to prevent damage to the engine.

Please also observe the instructions of the aircraft manufacturer. They are specially adapted for operation of the engine in the aircraft.



Caution:

Familiarize yourself with the layout of the engine controls in your aircraft according to the instructions of the aircraft manufacturer. Pay special attention to those controls needed to master an emergency situation.

The aircraft manufacturer must ensure that the operating limits specified by us are monitored, not exceeded and made understandable to the user by using display instruments. This concerns performance data, speed limits, pressure and temperature data.



Caution:

The specified operating limits are only permissible for short periods. Continuous operation at the operating limit can reduce the engine lifetime and lead to engine failure.

3 Engine Description

- Horizontally Opposed 4-Cylinder 4-Stroke Reciprocating Engine
- Ram Air Cooling
- Wet Sump Forced Lubrication
- Single Magneto Ignition
- Direct Propeller Drive
- Electrical Starter
- Alternator
- Mechanical Fuel Pump
- Constant Pressure Carburetor

3.1 Model Designation

L 1700 E A 1 . X X
1. 2. 3. 4. 5. 6. 7.

1. LIMBACH (Manufacturer)
2. Displacement Class in cm³
3. (E) Single Ignition
4. Equipment - Basic Type of Construction

0 = Tractor Propeller
Carburetor rear, bottom
Alternator rear
Starter rear

A = Tractor Propeller
Carburetor rear, top
Generator front
Starter front

B = Tractor Propeller
2 Carburetors rear, top
Generator rear
Starter rear

C = Pusher Propeller
Carburetor rear, bottom
Alternator rear
Starter rear

D = Tractor Propeller
Carburetor rear, bottom
Generator front
Starter front

170.253.905.000

5. Type of Propeller Flange

- 1 = Flange for Variable-Pitch Propeller
- 2 = Flange for Fixed-Pitch Propeller

6 + 7. Installation

Type Differences with regard to installation related changes

- X = Experimental Engine without Certification

3.2 Cylinder Designation

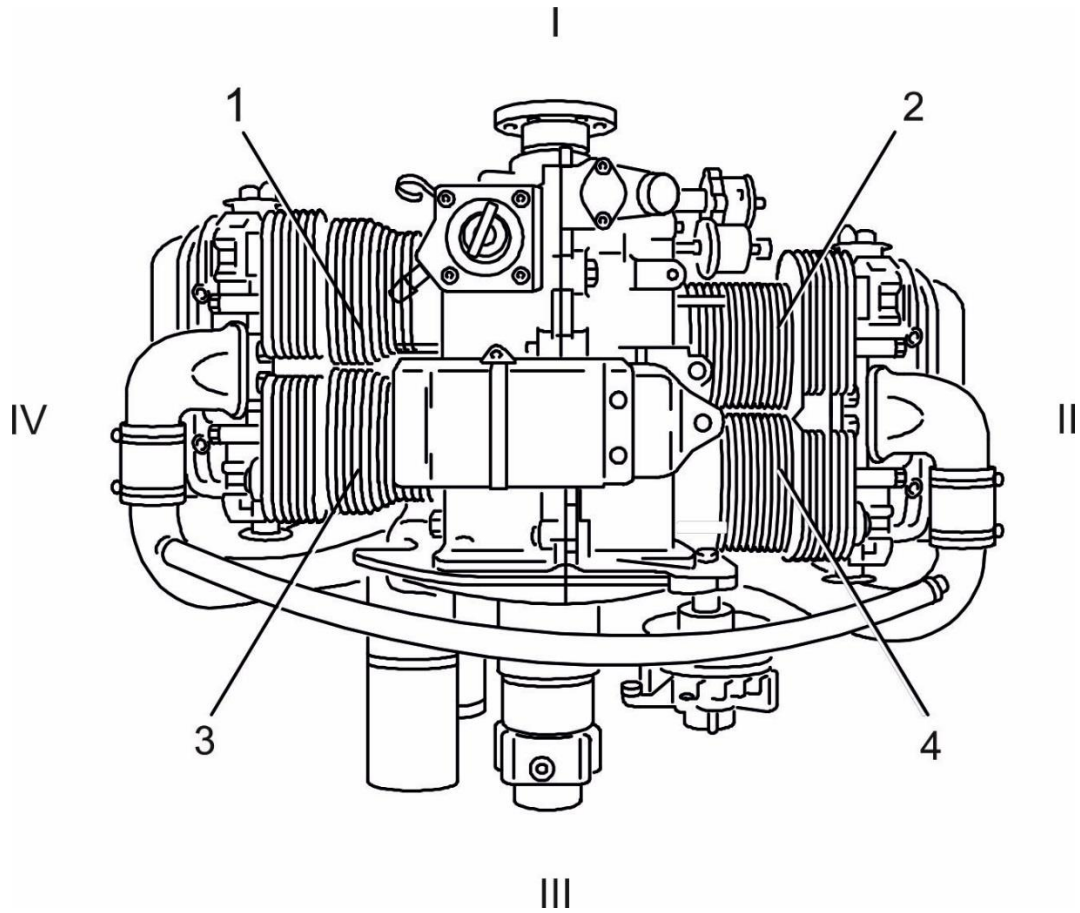

- I = front = propeller side
- II = right
- III = rear = accessory mounting side
- IV = left
- 1 = cylinder 1
- 2 = cylinder 2
- 3 = cylinder 3
- 4 = cylinder 4

4 Technical Data

4.1 LIMBACH L 1700 E0

Dimensions

Bore	88 mm
Stroke	69 mm
Displacement per Cyl.	420 cm ³
Total Displacement	1680 cm ³
Compression Ratio	8 : 1
Crankshaft Rotation	counterclockwise
Magneto Timing	30° BTC
Firing Order	1-3-2-4

Equipment

Magneto	SLICK 4230 SLICK 4330, P/N: 170.120.020 BENDIX S4RN21
Spark Plugs	EYQUEM A 755 LIMBACH LB-N41.0 LIMBACH LB-K-2, P/N: 170.123.104 (unshielded) LIMBACH LB-K-3, P/N: 170.123.105 (shielded)
Ignition Harness	SLICK-High-Temperature-Harness LIMBACH, P/N: 170.123.022 (unshielded) LIMBACH, P/N: 170.123.020 (shielded)
Carburetor	STROMBERG ZENITH 150 CD 3
Fuel Pump	APG - LIMBACH LIMBACH, P/N: 170.090.013
Alternator	DUCELLIER 14V-28A, P/N: 170.113.001 BOSCH 14V-33A
Starter	FIAT 0.7kW BOSCH 1.4kW MAGNETON 1kW, P/N: 250.143.010
Oil Pump	Geared Pump
Oil Filter	Oil Screen
Propeller Flange for E01	170.031.310
E02	170.031.300 (Version for new crankshaft)
E02	170.031.301 (Version for exchange crankshafts)

Note:

Preferred propellers:

Fixed-Pitch Propeller:

Hoffmann HO11*/HO11A
Mühlbauer MT

Variable-Pitch Propeller:

Hoffmann HO-V62
Mühlbauer MTV-1

By means of the adapter 202.032.320, the propeller flange for E01 may be used for fixed pitch propellers for E02, too.

Engine Ratings

Max. Take-Off Power	50 kW / 68 shp @ 3600 RPM
Max. Continuous Power	44 kW / 60 shp @ 3200 RPM

Engine Rotational Speeds

Max. permissible speed	3600 RPM
Max. speed for cruise	See flight and maintenance manual of airframe manufacturer.
Min. continuous speed	2300 RPM
Idle speed	800 ± 100 RPM

Fuel and Oil

Fuel	see section 10
Engine Oil	see section 10

Pressures and Temperatures

Fuel Pressure	0.1 to 0.15 bar / 1.45 to 2.17 psi
Engine Oil Pressure max.*)	4 bar / 58 psi
min.	1 bar / 14.5 psi @ 2500 RPM
Engine Oil Temperature max.*)	120 °C
min	50 °C (indicated)
opt.	appr. 80 °C
Cylinder Head Temperature max.*)	250 °C
opt.	150 to 170 °C (at cruise)

Oil Charge

Engine Oil Charge max.	2.5 l
min.	1.5 l

170.253.905.000

*) Operating limit - only permissible for a short period!
Continuous operation at the operating limit can reduce the engine lifetime.

4.2 LIMBACH L 1700 EA

Dimensions

Bore	88 mm
Stroke	69 mm
Displacement per Cyl.	420 cm ³
Total Displacement	1680 cm ³
Compression Ratio	8 : 1
Crankshaft Rotation	counterclockwise
Magneto Timing	30° BTC
Firing Order	1-3-2-4

Equipment

Magneto	SLICK 4230 SLICK 4330, P/N: 170.120.021 BENDIX S4RN21
Spark Plugs	EYQUEM A 755 LIMBACH LB-N41.0 LIMBACH LB-K-2, P/N: 170.123.104 (unshielded) LIMBACH LB-K-3, P/N: 170.123.105 (shielded)
Ignition Harness	SLICK-High-Temperature-Harness LIMBACH, P/N: 170.123.022 (unshielded) LIMBACH, P/N: 170.123.020 (shielded)
Carburetor	STROMBERG ZENITH 150 CD 3
Fuel Pump	APG - LIMBACH LIMBACH, P/N: 170.090.014
Alternator	DUCELLIER 14V-28A, P/N: 170.113.005
Starter	BOSCH 0.4kW SJCE 0.4kW MAGNETON 1kW, P/N: 202.143.030 *) MAGNETON 1kW, P/N: 202.143.130 **)
Oil Pump	Geared Pump
Oil Filter	Oil Screen
Propeller Flange for EA1	171.031.355 (Version for new crankshaft)
EA1	171.031.356 (Version for exchange crankshafts)
EA2	170.031.300 (Version for new crankshaft)
EA2	170.031.301 (Version for exchange crankshafts)

Note:

Preferred propellers:

Fixed-Pitch Propeller:

Hoffmann HO11*/HO11A
Mühlbauer MT

Variable-Pitch Propeller:

Hoffmann HO-V62
Mühlbauer MTV-1

By means of the adapter 202.032.320, the propeller flange for EA1 may be used for fixedpitch propellers for EA2, too.

170.253.905.000

*) For starter disc P/N: 171.039.005 and 171.039.001

***) For starter disc P/N: 202.039.001

4.3 LIMBACH L 1700 EB

Dimensions

Bore	88 mm
Stroke	74 mm
Displacement per Cyl.	450 cm ³
Total Displacement	1800 cm ³
Compression Ratio	8 : 1
Crankshaft Rotation	counterclockwise
Magneto Timing	30° BTC
Firing Order	1-3-2-4

Equipment

Magneto	SLICK 4230 SLICK 4330, P/N: 170.120.020 BENDIX S4RN21
Spark Plugs	EYQUEM A 755 LIMBACH LB-N41.0 LIMBACH LB-K-2, P/N: 170.123.104 (unshielded) LIMBACH LB-K-3, P/N: 170.123.105 (shielded)
Ignition Harness	SLICK-High-Temperature-Harness LIMBACH, P/N: 170.123.022 (unshielded) LIMBACH, P/N: 170.123.020 (shielded)
Carburetor	2 x STROMBERG ZENITH 150 CD 3
Fuel Pump	APG - LIMBACH LIMBACH, P/N: 170.090.013
Alternator	DUCELLIER 14V-28A, P/N: 170.113.001 BOSCH 14V-33A
Starter	FIAT 0.7kW BOSCH 1.4kW MAGNETON 1kW, P/N: 250.143.010
Oil Pump	Geared Pump
Oil Filter	Oil Screen
Propeller Flange for EB1	170.031.310
EB2	170.031.300 (Version for new crankshaft)
EB2	170.031.301 (Version for exchange crankshafts)

Note:

Preferred propellers:

Fixed-Pitch Propeller:
Hoffmann HO11*/HO11A
Mühlbauer MT

Variable-Pitch Propeller:
Hoffmann HO-V62
Mühlbauer MTV-1

By means of the adapter 202.032.320, the propeller flange for EB1 may be used for fixedpitch propellers for EB2, too.

Engine Ratings

Max. Take-Off Power	53 kW / 72 shp @ 3600 RPM
Max. Continuous Power	48 kW / 66 shp @ 3200 RPM

Engine Rotational Speeds

Max. permissible speed	3600 RPM
Max. speed for cruise	See flight and maintenance manual of airframe manufacturer.
Min. continuous speed	2300 RPM
Idle speed	800 ± 100 RPM

Fuel and Oil

Fuel	see section 10
Engine Oil	see section 10

Pressures and Temperatures

Fuel Pressure	0.1 to 0.15 bar / 1.45 to 2.17 psi
Engine Oil Pressure max.*)	4 bar / 58 psi
min.	1 bar / 14.5 psi @ 2500 RPM
Engine Oil Temperature max.*)	120 °C
min	50 °C (indicated)
opt.	appr. 80 °C
Cylinder Head Temperature max.*)	250 °C
opt.	150 to 170 °C (at cruise)

Oil Charge

Engine Oil Charge max.	2.5 l
min.	1.5 l

170.253.905.000

*) Operating limit - only permissible for a short period!
Continuous operation at the operating limit can reduce the engine lifetime.

4.4 LIMBACH L 1700 EC

The technical data of the LIMBACH L 1700 EC model are identical to the technical data of the LIMBACH L 1700 E0 model.

"C" indicates the changes concerning the axial bearing for rear engine installation (pusher propellers).

Due to the rear installation (pusher), the propeller shaft rotation is changed to clockwise (in direction of flight).

4.5 LIMBACH L 1700 ED

Dimensions

Bore	88 mm
Stroke	69 mm
Displacement per Cyl.	420 cm ³
Total Displacement	1680 cm ³
Compression Ratio	8 : 1
Crankshaft Rotation	counterclockwise
Magneto Timing	30° BTC
Firing Order	1-3-2-4

Equipment

Magneto	SLICK 4230 SLICK 4330, P/N: 170.120.021 BENDIX S4RN21
Spark Plugs	EYQUEM A 755 LIMBACH LB-N41.0 LIMBACH LB-K-2, P/N: 170.123.104 (unshielded) LIMBACH LB-K-3, P/N: 170.123.105 (shielded)
Ignition Harness	SLICK-High-Temperature-Harness LIMBACH, P/N: 170.123.022 (unshielded) LIMBACH, P/N: 170.123.020 (shielded)
Carburetor	STROMBERG ZENITH 150 CD 3
Fuel Pump	APG - LIMBACH LIMBACH, P/N: 170.090.014
Alternator	DUCELLIER 14V-28A, P/N: 170.113.005
Starter	BOSCH 0.4kW SJCE 0.4kW MAGNETON 1kW, P/N: 202.143.030 *) MAGNETON 1kW, P/N: 202.143.130 **)
Oil Pump	Geared Pump
Oil Filter	Oil Screen
Propeller Flange for ED2	170.031.300 (Version for new crankshaft)
ED2	170.031.301 (Version for exchange crankshafts)

Note:

Preferred propellers:

Fixed-Pitch Propeller:
Hoffmann HO11*/HO11A
Mühlbauer MT

*) For starter disc P/N: 171.039.005 and 171.039.001

***) For starter disc P/N: 202.039.001

5 Performance

5.1 Performance Graph LIMBACH L 1700 E0 and L 1700 EC

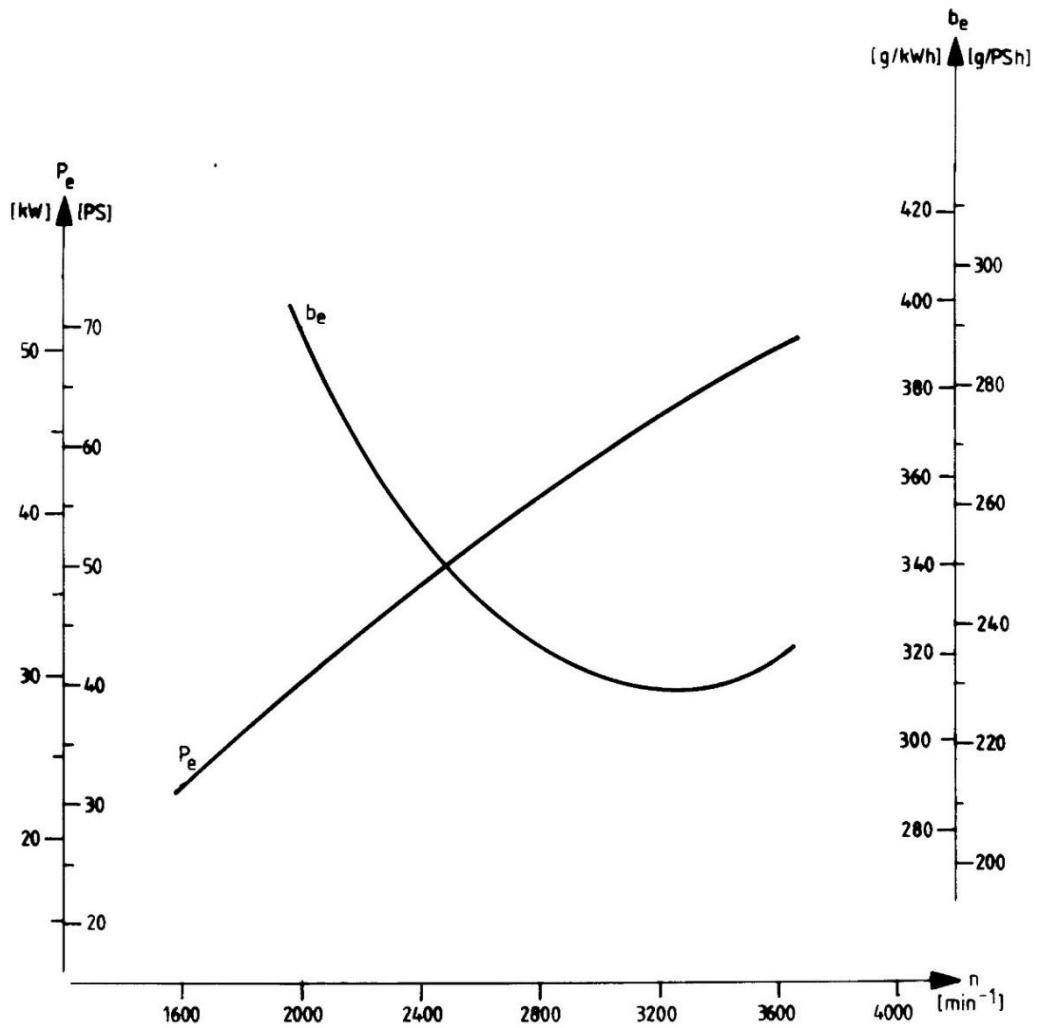

170.253.905.000

5.2 Performance Graph LIMBACH L 1700 EA

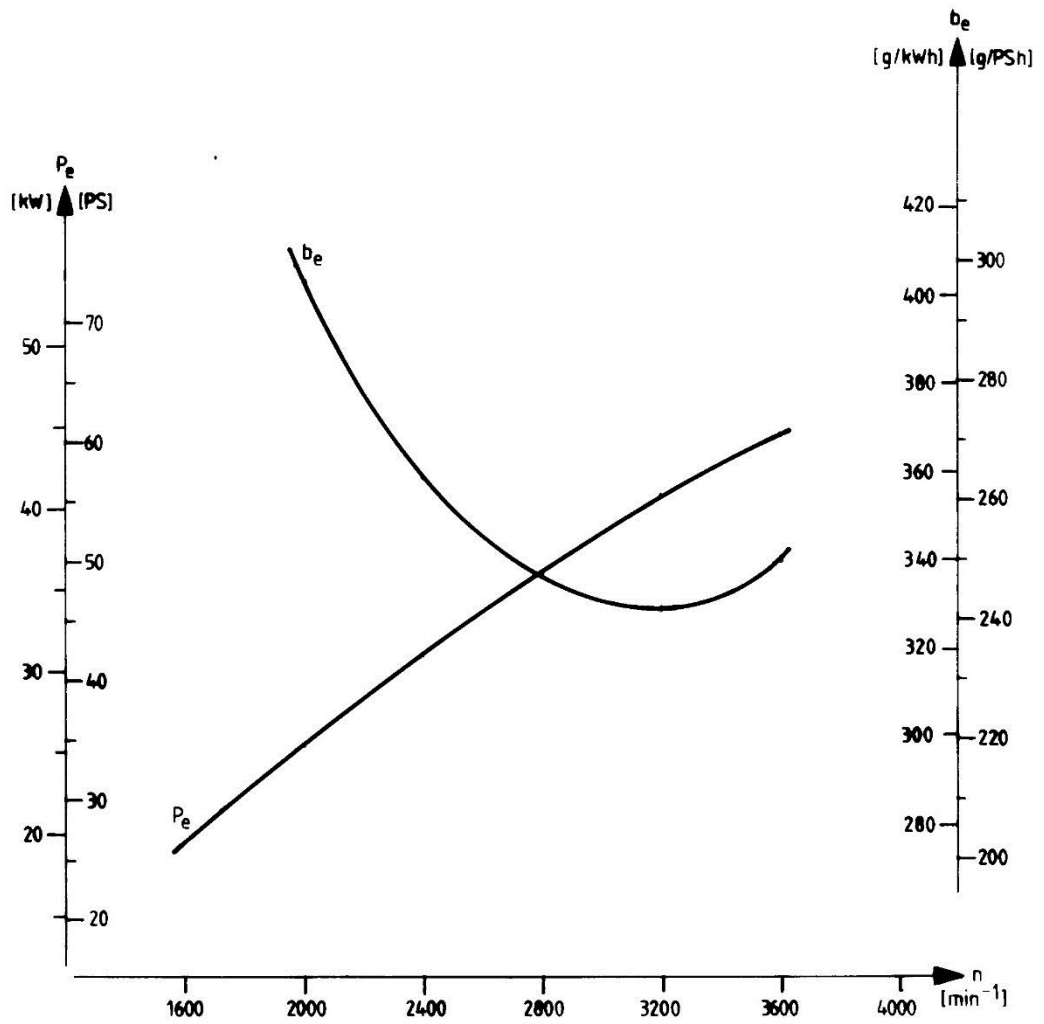

170.253.905.000

5.3 Performance Graph LIMBACH L 1700 EB

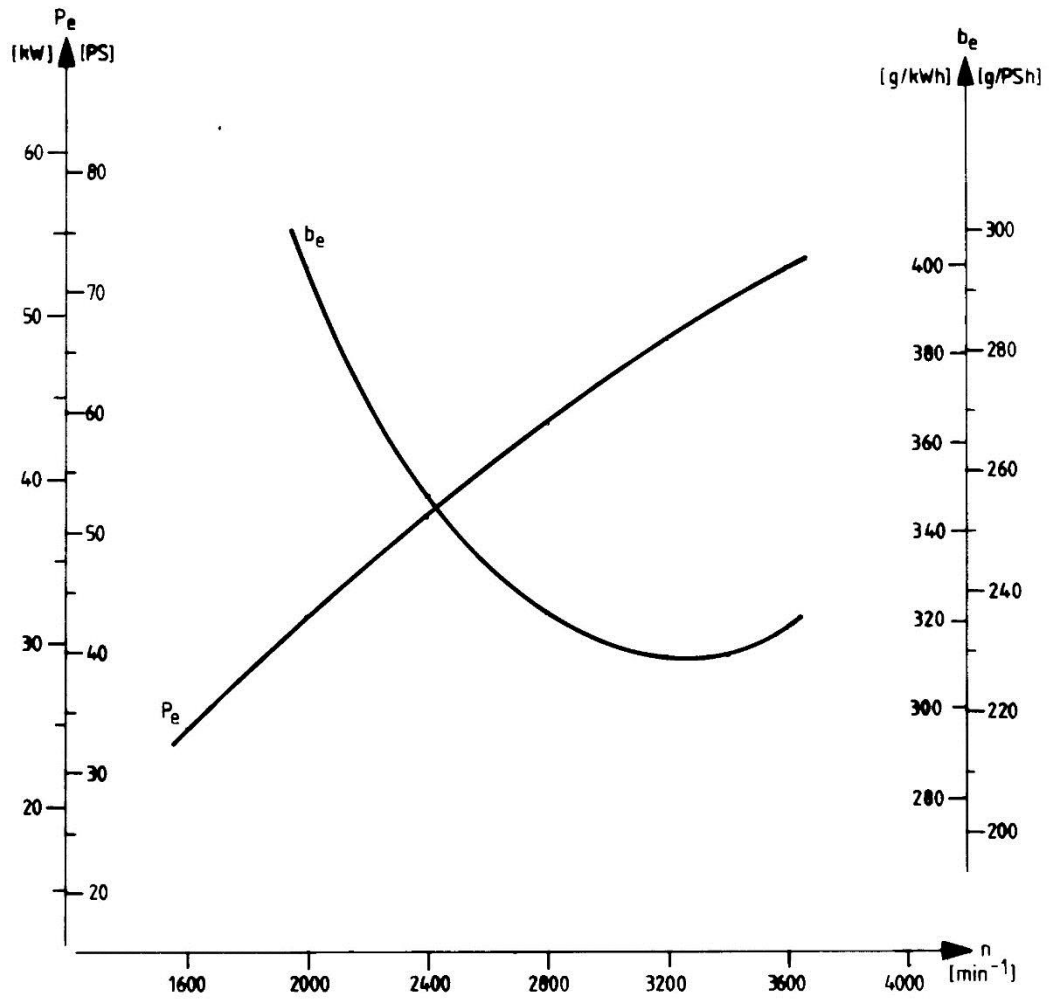

170.253.905.000

5.4 Performance Graph LIMBACH L 1700 ED

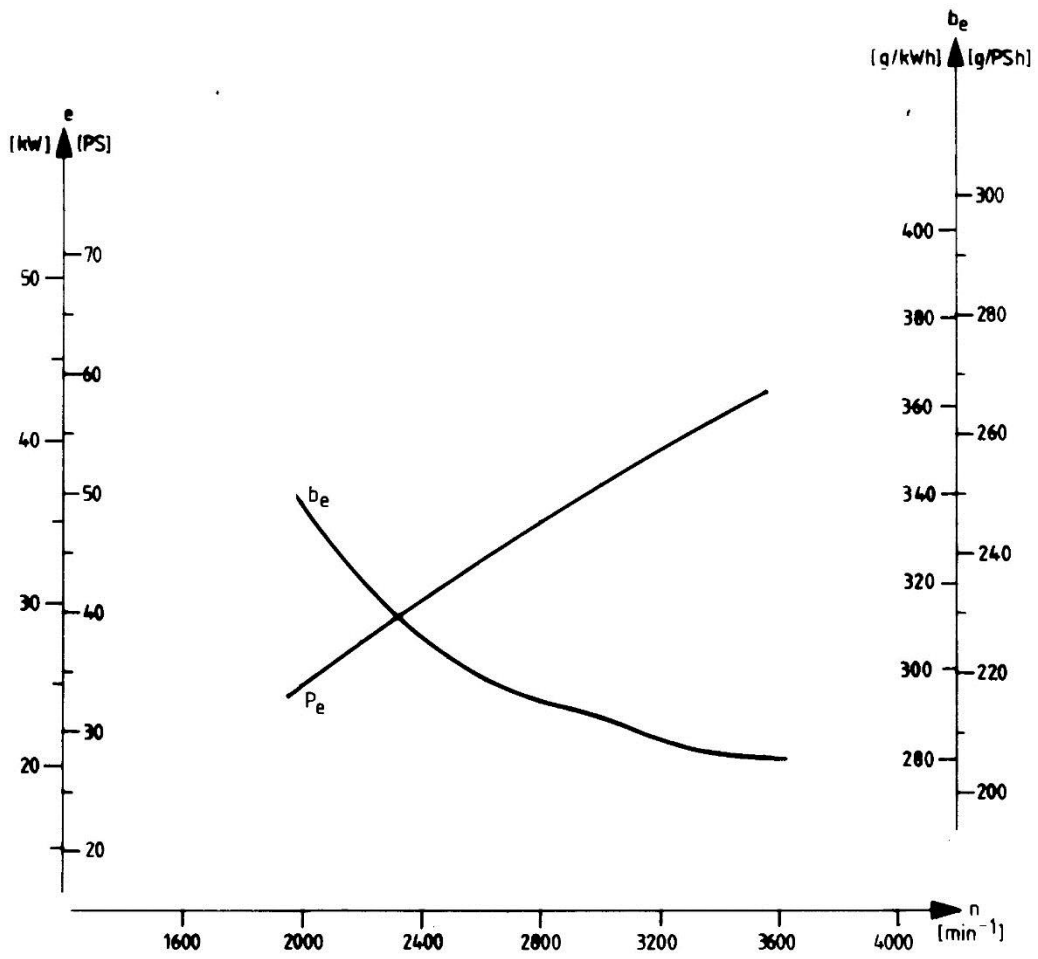

170.253.905.000

6 Operating Instructions

Strict adherence to the information contained in this operating manual is the basis for undisturbed operation of your engine.

6.1 Before Starting

Perform daily check (see section 7.1)

Move power lever to throttle full open position.

Check for interference and free movement between the idle cutoff and full open stops at the carburator.

Check function of choke button.

Choke must move to the full open and closed positions.

Switch ignition to „Off“

Remove spark plug connectors from the spark plugs.
Unscrew connectors on shielded spark plugs.

Turn propeller by hand several times

Check function of impulse coupling of magneto(s) and for abnormal sound and rough movement of the engine.

Reassemble spark plug connectors.

Note:

Engines that are equipped with a vacuum pump may never be turned against the normal sense of engine rotation. Damage to the vacuum pump may occur.



Caution:

Turning the propeller by hand may only be performed with the spark plugs unconnected!

6.2 Engine Start-Up



Caution:

When starting the engine, the propeller area must be clear. No persons may be present in the propeller area.

Open fuel shutoff valve.

Switch electrical fuel pump (if any).

Operate choke button.

Move the throttle lever to 5-10 % power.

Turn master switch and ignition on.

Check propeller clearance.

Start engine.

When the engine is firing, release starter button and set engine speed to 1000 - 1200 RPM by means of the throttle lever.

Disengage choke.

Check oil pressure (must increase within 10 sec.).

6.3 Runup, Performance Check

Run the engine for approx. 2 min. at 1000 - 1200 RPM. Then increase speed to 1500 RPM until oil temperature is 50 °C.

Due to the sluggish action of the indication, there will be sufficient effective operating temperature at 50 °C already.

6.3.1 Performance Check

Move throttle lever to full-throttle stop. **Engine has to reach the full-throttle static speed** published in the flight and maintenance manual of the aircraft manufacturer. Return throttle lever to idle.

6.3.2 Check carburetor heating for proper functioning

Refer to the flight and maintenance manual of the aircraft manufacturer.



Caution:

If full-throttle ground runs are made for a longer period, overheating of the engine is possible!

6.4 Hot Engine Start-Up

Hot engine starting is performed as described in Chapter 6.2, but **with choke closed**. After starting run the engine with increased idle speed (1500 RPM) for approx. 3 to 4 min., in order to assure that there will be no vapor lock in the fuel system.

6.5 Take-Off

Increase engine speed steadily to full throttle and perform first part of climb with this setting, then reduce power.

Check oil temperature and oil pressure. The limit values must not be exceeded.



Caution:

With increasing ambient temperatures the engine power and the lift up of the wings will be reduced. This applies especially to situations in which the runways has been heated up by sunlight!

6.6 Engine Shut-Down

Shut engine down by switching ignition off.



Caution:

After taxiing for an extended period or at high power, run the engine at 1000 - 1200 RPM for 2 to 3 min.

Close fuel shutoff valve.

6.7 Inflight Shut-Down and Restarting

Set throttle to idle, let engine cool down and switch off ignition.

To avoid windmilling bring propeller into feathered position. On aircraft with fixed pitch propeller activate propeller brake or reduce speed.

Starting engine is the same as on the ground.

As long as the engine is still warm, do not activate cold start device.

If the engine is cold, perform warm-up.

At low ambient temperatures and after prolonged soarings:

- the engine oil may have cooled so much, that the engine cannot be started anymore
- the capacity of the starting battery may be reduced (see section 8.22)



Caution:

Make sure that you have sufficient altitude to restart the engine, especially at low ambient temperatures and prolonged soarings.

6.8 Engine operation on hot days

The fuel pump operation may be disturbed because of vapor locks, when operating the engine on hot days and/or in altitude conditions.

As a remedy we recommend retrofitting an additional electric fuel pump. Please consult your aircraft manufacturer for additional information.

In general only such fuels approved by Limbach shall be used (see section 10.2)

7 Maintenance Schedule

Maintenance at Limbach aircraft engines is to be performed after fixed time periods or when reaching a certain interval of operating hours. In addition, a "daily check" has to be performed before each flight.

Repair activities during engine maintenance may only be performed by authorized persons. Therefore, the specifications together with the technical documents of Limbach Flugmotoren GmbH must be observed!

For inspection and repair work on ignition magnetos, the instructions and specifications of the manufacturer of the BENDIX or SLICK ignition magnetos must generally be followed.

7.1 Daily Check

- Remove engine cowling.
- Check bolted connections.
- Check baffle assembly.
- Check harness.
- Check condition of drive belt.
- Check cowling for cracks and correct attachment.
- Check clearance of throttle pushrods and bowden cables.
- Check engine oil level and refill as necessary.
Volume difference between max. and min. markings: 1 l.
- Check oil and fuel system for leakage.
- Perform test run (see section 8.20).

7.2 Periodical Checks

7.2.1 Every 6 Months Following 100 h Inspection

Check carburetor diaphragm of the Stromberg-Zenith carburetor for brittleness, strain or cracks and replace, if necessary.

7.2.2 Every 2 Years

Disassemble and check magneto and replace as necessary (SLICK 4230, 4330 only) *)

7.2.3 Every 4 Years

Replace spider coupling for magneto clutch (L 1700 E0, EB, EC).

7.2.4 Every 5 Years after engine manufacture or major overhaul

Replace oil and fuel hoses (mounted to the engine).

The oil and fuel hoses mounted to the engine are signed with a lapse date, e.g. 5.15 - i.e. to be replaced not later than May 2015.

7.2.5 Every 12 Years

Major overhaul of the ignition magneto (SLICK 4230, 4330 only) **)

*) Every 2 years or every 250 operating hours (whichever comes first).

***) Every 12 years or every 1000 operating hours (whichever comes first).

7.3 Operating Time related Inspections

	7.3.1	7.3.3	section 7.3.4	7.3.5	7.3.6	7.3.7
After 5 Operating hours	X					
After 25 Operating hours			X			
Every 25 Operating hours		X				
Every 50 Operating hours			X			
Every 100 Operating hours			X	X		
Every 250 Operating hours			X		X	
Every 500 Operating hours			X	X	X	X

7.3.1 After the first 5 Operating hours

- Check valve clearance, replace cylinder head cover gasket as necessary.

7.3.2 After the first 25 Operating hours

- Work as specified in Chapter 7.3.4

7.3.3 Every 25 Operating hours

- Grease magneto couplings. Applicable to all engines except L 1700 EA, ED.

7.3.4 Every 50 Operating hours

- Check fuel and lubrication system.
- Clean engine.
- Check crankcase ventilation.
- Clean induction air filter or replace, if necessary.
- Change engine oil, clean oil screen.
- Check valve clearance, replace cylinder head cover gasket as necessary.
- Check compression.
- Clean and check spark plugs (see section 8.14).
- Check drive belt tension.
- Check and grease throttle pushrods and bowden cables.
- Check oil level of Stromberg-Zenith carburetors..
- Grease magneto couplings (except L 1700 EA, ED).
- Visual inspection of the ignition magneto and checking of the ignition timing, adjust if necessary.
- Check harness.
- Check bolts, nuts, safety pins, and engine mounting frame for tight fit and proper condition.
- Perform engine test run. (see section 8.20).

7.3.5 Every 100 Operating hours

- Check carburetor diaphragm of the Stromberg-Zenith carburetor.
- Clean fuel pump screen.
- If there is still a permissible dimension of 24,5 mm, check valve shaft projection length for intake and exhaust valves. See Service Bulletin No. 13, current edition.
- Work as specified in section 7.3.4

7.3.6 Every 250 Operating hours

- Disassemble and check magneto and replace as necessary (SLICK 4230, 4330 only). *) **)
- Work as specified in section 7.3.4

7.3.7 Every 500 Operating hours

- Disassemble and check magneto and replace as necessary. (BENDIX S4RN21 only).
- Replace float valve.
- Check play of throttle shaft (L 1700 EB only).
- Check valve shaft projecting length.
- Work as specified in section 7.3.4
- Work as specified in section 7.3.5
- Work as specified in section 7.3.6

7.4 Unscheduled replacement of components

Ignition magnetos must be replaced if one of the following cases occur:

- in case of a sudden engine stoppage
- in case of lightning strike
- in case of shock loading, propstrike or immersion

(For details - see Service Bulletin No. 11, current edition)

*) Every 2 years or every 250 operating hours (whichever comes first).

***) Major overhaul of the magnetos every 12 years or every 1000 operating hours (whichever comes first).

8 Maintenance Instructions

This chapter describes the performance of maintenance work. In addition, the preservation of engines as well as winter and tropical operation is covered.

Repair activities during engine maintenance may only be performed by authorized persons.



Caution:

Disconnect spark plug connectors before performing any work on the engine. Unscrew connectors on shielded spark plugs.



Caution:

When starting the engine, the propeller area must be clear. Secure the aircraft from rolling. No persons may be present in the propeller area.

Note:

Vacuum pump equipped aircraft engines must never be turned opposite to the engine rotation because the vacuum pump might be damaged.

Check with your airworthiness inspector if inspection is mandatory before starting work.

It is recommended to mark the position of parts to be removed before commencing disassembly work in order to facilitate assembly later on. This is only applicable to parts which might be installed in different positions. During assembly, pay attention to markings provided by the manufacturer (e.g. magneto timing markings).

Loosened screw connections must be secured! After loosening the screw connections, new locking elements (securing wire, split washer, spring washers, safety plates, etc.) must be inserted.

8.1 Oil Change

Warm up engine.

Drain oil.

Remove five cap nuts from the oil screen cover and unfasten the sixth. Lift oil screen cover from the case by means of a screwdriver and drain oil. The engine must be horizontally orientated.

Clean oil screen.

Wash oil screen in gasoline used for cleaning purposes and clean it off by using compressed air.

Mount oil screen.

Replace sealings, gaskets and self-locking cap nuts!

Refill engine oil.

The oil charge is 2.5 l. Check oil level by means of the oil-measuring stick. The MAX marking must not be exceeded. The engine must be horizontally orientated. This is especially important for so called "taildragger" Aircraft.

See section 10.1 for oil specifications.

8.2 Cleaning of Air Filter

Remove induction air filter.

Clean air filter.

Replace dry air filter (cloth filter).

Wash oil-wetted air filter (wire screen) in gasoline, clean it off by using compressed air and wet with oil.

Special filters are to be cleaned according to the aircraft manufacturer's instructions.

8.3 Check and greasing of Carburetor control

Check pushrods and joints.

Ball socket seats must not be worn out.

Lubricate joints with engine oil.

8.4 Replacing of Float Valve

Remove carburetor.

Remove fuel bowl.

Remove float and needle valve.

Check float position.

Use new seals for reassembly.

8.5 Check / replacement of Carburetor Diaphragm

Unscrew and demount piston damper.

Dismounting of carburetor diaphragm.

Remove carburetor cover.

Take out compression spring and diaphragm with piston.

Check of carburetor diaphragm.

Check carburetor diaphragm for cracks and extensions and replace, if necessary.

Replacement of carburetor diaphragm.

Remove mounting bolts from piston and demount diaphragm with clamping ring.

Attach new diaphragm to piston so that the cam at the inner edge of the diaphragm will engage to the respective slot of the piston.

Attach clamping ring and fasten with bolts.

Installation of piston with diaphragm.

Insert piston into carburetor so that the cam at the outer edge of the diaphragm will engage to the respective slot of the carburetor housing. Attach carburetor cover and fasten with bolts.

Installation of piston damper.

Check oil level in the piston guide and correct as necessary.

Tighten piston damper manually.

8.6 Carburetor Oil level check

Unscrew piston damper.

Check oil level and correct as necessary.

Oil level should be approx. 4 mm below the top edge of the piston guide (the piston guide has two opposite notches at the top edge). For refilling, use carburetor damper oil only (P/N: 170.210.005).

Overfilling of the piston guide is not dangerous - excess oil will be fed to the combustion process of the engine.

Install piston damper.

8.7 Fuel Pump Screen cleaning

8.7.1 Engines with APG Fuel Pump

Close fuel shutoff valve.

Removal of screen.

Unscrew mounting bolt of the pump cover.
Demount cover and screen with sealing.

Cleaning of screen.

Wash the screen by means of gasoline used for cleaning purposes and clean it out by using compressed air.

Installation of screen.

Use new sealings for screen and mounting bolt.
Oil mounting bolt slightly before installation.

8.7.2 Engines with Limbach Fuel Pump

Close fuel shutoff valve.

Disconnect fuel lines from pump. Disassemble top of the fuel pump (6 screws). Collect any fuel dripping from the pump.

Disassemble valve assy from top of fuel pump with a suitable tool.



Remove o-ring and strainer from top of pump.

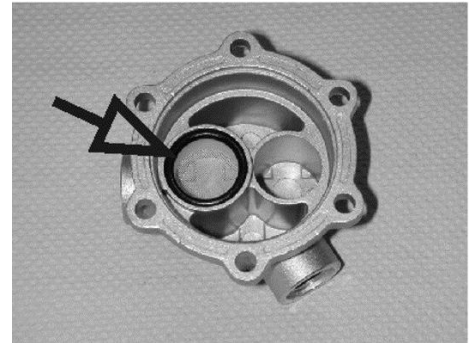

Clean housing. Insert strainer and new o-ring. Insert valve assy until flush with the flange of the cover.

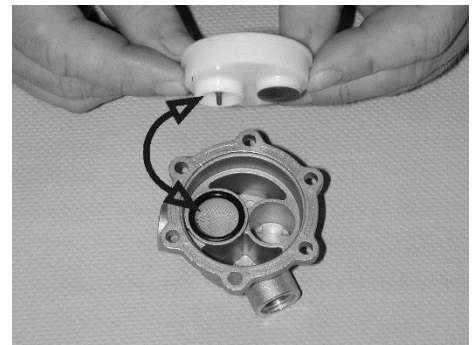

Rotate crankshaft until the diaphragm of the fuel pump is in the lowest position. The plate of the diaphragm (1) is flush with the fuel pump housing (2).

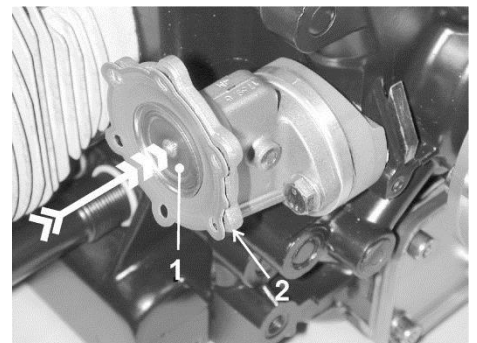

Attach top of the fuel pump and tighten screws.
Reassemble fuel hoses with new gaskets and sealing rings. Tighten hollow bolts and secure with safety wire.

Open fuel valve.

Perform test run and check for leaks.

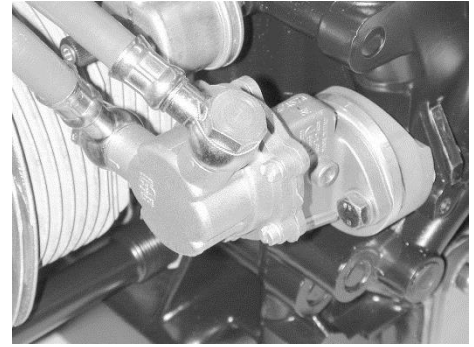

8.8 Fuel Filter cleaning

Draining and cleaning of fuel filter.

Refer to flight and maintenance manual of aircraft manufacturer.

8.9 Fuel and Lubrication System leakage check

Check all hoses, hose connections, fittings, related equipment and engine casing joints for leaks, proper attachment, installation and replacement periods.

8.10 Crankcase Ventilation Check

Check visually for damages and clean breather line as necessary. Check suitability and installation of breather line - it has to be stable at engine operating temperatures (danger of buckling) and must be installed properly (no bucklings, no reduction in cross-sectional area, no suction effects at the end of the line).

8.11 Compression Check

Compression checks should be performed when the engine is "warm to touch".

Remove spark plugs.

Measure compression by means of a compression pressure recorder.

Perform measurement with throttle full **open**. Record compression pressure at starting RPM for every cylinder until the recorder doesn't show any more pressure rise.

Wear limit: 6 bar / 87 psi.

Permitted pressure difference: 2 bar / 29 psi

8.12 Check and Setting of Valve Clearance

Valve clearance must be checked or set only at cold engine (ambient temperature).



Caution:

**Disconnect spark plug connectors before performing any work on the engine.
Unscrew connectors on shielded spark plugs.**

Remove valve cover.

Valve clearance check.

Turn propeller according to engine rotation until the valves of the second cylinder are overlapping. Now, the valve clearance of the first cylinder may be checked (see cylinder designation at page 3.2).

Move thickness gauge between valve shaft and setscrew. The thickness gauge must be movable slightly "sucking". It must not jam.

Valve clearance setting.

Untighten nut of setscrew and turn setscrew until thickness gauge can be moved slightly "sucking". Tighten nut and check valve clearance again, readjust, if necessary.

Order of adjustment

The order of adjustment is: 1 - 3 - 2 - 4, i.e. the propeller has to be turned by 180° after the first cylinder has been set, in order to check the valve clearance of the third cylinder. After another 180° turn according to the engine rotation, the valve clearance of the second cylinder may be checked, etc.

Valve clearance: Intake Valve 0.20 mm
 Exhaust Valve 0.20 mm

Check cylinder head cover gaskets and replace, if necessary.

8.13 Check valve shaft projection length for intake and exhaust valves

Remove cylinder head covers.

Dismount rocker arm shafts.

Measurement of valve shaft projecting length by means of measuring device P/N: 803.001.130. See Service Bulletin No. 13, current edition.



Caution:

With a still permissible dimension of 24,5 mm, the valve shaft projection length must be checked every 100 hours. When the wear limit of 24,0 mm is reached, the cylinder head must be replaced!

Install rocker arm shafts.

- Apply sealant P/N: 708.413.070 to the sealing face of the bearing blocks.
- Position rocker shafts on the studs.
- Insert push rods into the cavities of the rocker arms.
- Pre-assemble spring washers and M8 nuts (strength class 10).
- Ensure that the pushrods are also seated in the camshaft followers.
- Torque nuts to 25 Nm

Note:

Turning the pushrods while tightening the bolts will prevent the pushrods from becoming unseated at the cam followers.



Caution:

An unseated pushrod may cause power loss and/or subsequent engine damage.

Check valve clearance and readjust, if necessary.
Mount cylinder head cover.
Check gaskets and replace as necessary.

8.14 Cleaning, Check and Setting of Spark Plugs

Removal of spark plugs.

Disconnect spark plug connectors.
Unscrew connectors on shielded spark plugs.



Caution:
Do not unscrew spark plugs when the engine is hot.

Cleaning of spark plugs.

Clean spark plugs by means of a plastic brush in a degreasing solution. Do not use a steel brush for cleaning. Do not sandblast spark plugs.

Check electrode gap and adjust, if necessary (not for spark plug LB-N41.0).

Check electrode gap with a nozzle gauge and correct by bending the ground electrode(s)

The electrode gap is 0.4 to 0.5 mm.

Install spark plugs, reattach spark plug connectors.

Grease spark plug thread with graphite grease P/N: 170.210.010.
Torque 25 Nm.



Caution:
Electrodes must always be free from graphite grease! Do not use copper paste.

Approved spark plugs.

See „Technical Data“.

It is recommended to change spark plugs every 150 operating hours.

Note:

The condition of the spark plugs removed from the engine discloses the following information:

Light grey:

- Spark plug and engine adjustment o.k.

Velvet black:

- Electrode gap too big
- Mixture too rich
- Lack of air (induction air filter contaminated)
- Engine does not reach required temperature

Oillike glossy:

- Interrupted spark plug operation
- Excess oil in combustion chamber
- Cylinder or piston rings worn out

Pearl formation:

- Wrong spark plug
- Loose spark plug
- Mixture too lean ("false air")
- Valves do not close properly
- Induction air temperature too high (carburetor shielding defective)

8.15 Drive Belt check, stretching and replacement

Drive belt check.

Check for wear, cracks and oil traces.

Drive belt tension check.

It must be possible to push the drive belt through with a strong thumb load by 5 to 10 mm.

Stretching of drive belt.

Unfasten mounting bolt of clamp at the crankcase or accessory housing. Unfasten mounting nut of alternator with locking at the clamp. Stretch drive belt by moving the alternator. Tighten and lock all bolts and nuts.

Replacement of drive belt.

Front-mounted alternator:

Mark position of propeller relative to starter ring gear and remove propeller.

Unfasten mounting bolts of clamp and detach drive belt from the belt pulley of the alternator.

Demount starter gear and remove drive belt.

Place new drive belt to starter gear and mount starter gear. Ignition timing markings at starter ring gear and propeller hub must be in coincidence.

Place drive belt to alternator belt pulley and stretch drive belt. Lock mounting screws.

Install propeller.

Check propeller blade track.



Caution:

After propeller installation airworthiness inspection is mandatory.

Rear mounted alternator and accessory housing with drive belt opening of 15 mm of width:

- Remove engine.
- Demount starter.
- Demount alternator.
- Demount magneto.
- Remove accessory housing.
- Replace drive belt.
- Mount accessory housing.
- Install starter.
- Install alternator.
- Install magneto.
- Stretch drive belt.
- Install engine.
- Check ignition timing.

Rear mounted alternator and accessory housing with drive belt opening of 40 mm of width:

- Unfasten mounting bolts of clamp and detach drive belt from belt pulley of alternator.
- Remove magneto and detach drive belt from crankshaft drive pulley.
- Attach new drive belt to crankshaft belt pulley and install magneto.
- Attach drive belt to alternator belt pulley and stretch drive belt.
- Tighten all mounting bolts.
- Check ignition timing.

New drive belts are stretching more during the first time of operation.
A check is required after 10 operating hours. Set belt tension as necessary.

8.16 Exhaust System Check

Check for damages, leaks and condition.
Refer to flight and maintenance manual of aircraft manufacturer.

8.17 Bowden Cable Check

Check for condition, ease of motion and proper attachment.
Refer to flight and maintenance manual of aircraft manufacturer.

8.18 Harness Check

Check proper installation, attachment and tight fit of connections and terminals. Vibration of harness during operation must be avoided.

8.19 Check of Bolted Connections

Check all accessible bolts and nuts for tight fit and check existing locks visually.

8.20 Engine Test Run

Check of starting performance.

At normal conditions (temperature, maintenance condition) the engine starts easily. If this is not the case check fuel supply and ignition system.



Caution:

Do not operate the starter a prolonged period of time (Risk of overheating).

Warming up

Run engine for approx. 2 min. between 1000 to 1200 min⁻¹. Then increase speed to 1500 rpm until the oil temperature gauge indicates 50 °C.

Temperatures and pressures

Refer to "Technical Data".

Check of throttle response.

Move power lever steadily to full throttle. Engine must show immediate response, engine speed must increase steadily.

Engine performance check.

Move throttle lever to full-throttle stop. Engine has to reach the full-throttle static speed (refer to flight and maintenance manual of aircraft manufacturer). Set variable pitch propellers to Take-off pitch.

8.21 Engine Preservation

Engines that are take out of operation for more than 6 months shall be preserved.

Note:

At high humidity, it is recommended to close the exhaust muffler exit.

8.21.1 Compliance

Installed engine:

- Warm up engine and drain engine oil after engine shut-down.
- Clean oil screen.
- Clean engine thoroughly.
- In any case, corrosion protection has to be performed by using fresh engine oil.
- Charge 2.5 l of engine oil and run engine for approx. half a minute with increased idle speed.
- Remove air filter and spray 25 to 30 cm³ of engine oil slowly into the carburetor(s) of the running engine. Stop engine during spraying.
- Wet all carburetor hinges with engine oil.
- Close all openings to avoid entry of dirt or moisture.
- Spray engine surface with engine oil. Take care of not exposing rubber parts and electrical connectors to engine oil.



Caution:

After corrosion protection, the engine must not run any more as this would disable corrosion protection.

Removed engine:

- Remove spark plugs and spray engine oil into the combustion chambers so that the upper part of the cylinder barrel is wetted, too. Crank engine manually or with starter for a few turns. Spray spark plugs with engine oil and install them again.
- Wet all carburetor hinges with engine oil.
- Close all openings to avoid entry of dirt or moisture.
- Spray engine surface with engine oil. Take care of not exposing rubber parts and electrical connectors to engine oil.

8.22 Operation at low ambient Temperatures

In general, engine maintenance should be performed before the beginning of the cold season. Furthermore, the following hints for operation at extremely low ambient temperatures should be observed:

Fuel system

At temperatures between - 5 °C and + 20 °C, especially at high humidity conditions, carburetor icing is possible. Under such weather conditions, monitor engine speed continuously and switch on carburetor heating as necessary.

If there is no carburetor preheat installed we strongly recommend retrofitting one. Please contact your aircraft manufacturer for information.

Electrical system

At low ambient temperatures, the capacity of the starting battery is reduced. This may lead to starting problems.

Check all wiring connections in the ignition system and clean as necessary, oxidized terminals cause voltage drops and thus starting problems.

Crankcase ventilation

At low ambient temperatures and high humidity, saponification of vent dome and breather line is possible. Make sure by means of special inspections that this cannot happen - a total lock might cause the engine oil to leak through the sealings due to overpressure. This would lead to high oil losses and possibly to the destruction of the engine.

Engine oil

For prolonged soaring (with stopped engine) please note that the viscosity of the engine oil increases extremely with the cooling down of the engine. In extreme cases the viscosity may have increased so much, that the starter cannot turn the engine anymore. When planning your flight, consider prolonged soaring and fill engine with appropriate oil. Eventually you should start the engine inbetween to warm up the engine oil again.

8.23 Operation in Tropical Conditions

The following measures are necessary to protect the engine against heat and dust:

Air induction filter

If the engine is operated in areas of high dust accumulation install larger air filter (contact your aircraft manufacturer for details).

Oil-measuring stick

Seal oil-measuring stick by inserting a felt washer below the oil stick cap. To achieve a tight fit of the oil stick in its guiding tube, bend stick as necessary.

Dust protection of engines out of operation

Close exhaust pipe, crankcase ventilation, and induction air filter with a dustproof sealing.

Corrosion protection of engines out of operation

The different actions are described in section 8.21

Maintenance hints:

Air filter: Check daily and clean or replace as necessary.

Drive belt: Check drive belt tension daily. If wear is evident, replace drive belt.

Fuel pump: Check fuel pump screen every week and clean, if necessary.

8.24 Miscellaneous

For further advice on maintenance and repair, refer to our maintenance instructions and technical bulletins.

9 Overhaul

9.1 Major Overhaul

Major overhaul must be performed by the manufacturer or overhaul shops, authorized by the manufacturer. Therefore, the engine has to be forwarded to the manufacturer or an authorized overhaul shop, after the operating time limit has been reached.

The permissible operating time (TBO) is determined by the latest issue of Technical Bulletin No. 9.

9.2 Major Repair

Major repair and major modifications must be performed only by the manufacturer or licensed fixed base operators, authorized by the manufacturer.

After ground or obstacle contact of the propeller, the engine has to be disassembled in any case and the crankshaft has to be checked outside the engine. Eccentricity measurement of crankshaft or propeller flange at installed conditions is inaccurate and not acceptable.

If ground or obstacle contact of the propeller has not been mentioned when ordering repair or major overhaul of an aero-engine, the liability of the owner for sequential damages will continue even after repair or major overhaul has been performed.

A change of the propeller hub has to be considered a major repair in any case.

10 Lubricants, Coolants, Fuels

10.1 List of Lubricants

Do not use ashless dispersant or straight mineral aircraft engine oils!

Do not use fully synthetic oils!

Use only brand name oils according to specification API-SG, or higher. (eg. API-SH, SI, SJ, S...) as well as one of Volkswagen-specs VW 500 00, VW 501 01 or VW 502 00.

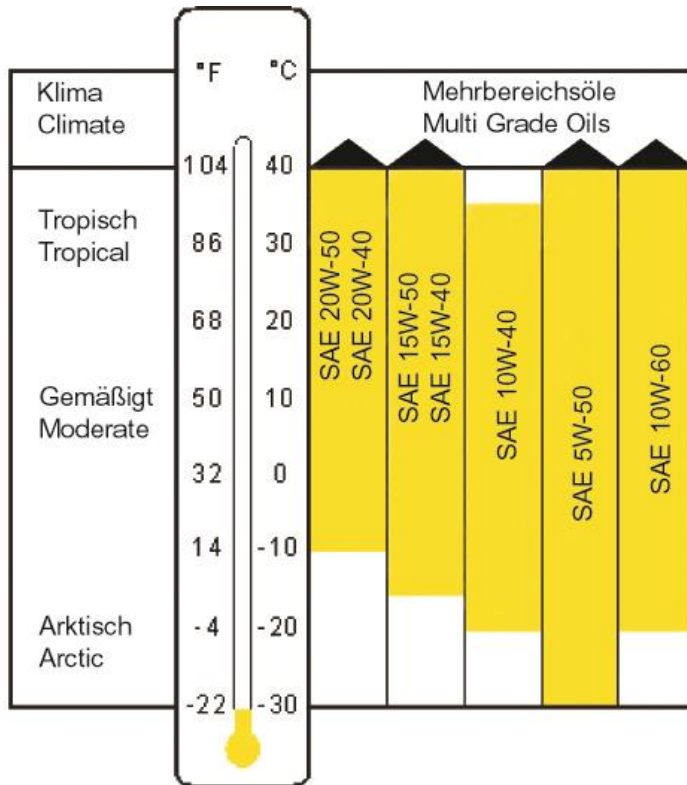

As the temperature ranges of adjacent SAE classes are overlapping, there is no need to change the oil for short time temperature variations.

If low viscosity oils are used, the oil pressure may go below the lower limit at continuously high engine speeds and high loads. Such operating conditions should be avoided.

Lubricant additives - no matter what type - must not be added to the oil.

10.2 Fuels

Following fuels are factory approved:

- Super Plus 98 fuel according to DIN EN 228,
- AVGAS 100 LL,
- or other unleaded fuels with a minimum octane rating of 98 RON and 87 MON.

Notes:

- Fuel hoses and lines must be suitable for fuel.*)
- Use fresh, brand name fuels only. Storage time for fuel is limited. If stored too long in ventilated containers, volatile components of the fuel may evaporate. That can change the properties of the fuel (reduced octane number). Also the fuel properties depend on the calendar season.
- Use of fuel additives is not permitted.
- Mixing of leaded and unleaded fuels is not recommended. Use mixed fuel only in case of need.



Caution:

Use of other fuels is not approved by the manufacturer.

*) Fuels may contain alcohol. Please consult the instructions of your aircraft manufacturer.

11 Recommended Tightening Torques

Oil screen cover to housing	7 Nm
Oil drainage screw to oil screen cover	35 Nm
Air filter to carburetor (M8)	20 Nm
Carburetor to induction pipe (M8)	20 Nm
Carburetor cover to carburetor	2 Nm
Fuel bowl to carburetor	2 Nm
Float valve to carburetor	12 Nm
Diaphragm to regulator piston	1 Nm
Crankcase ventilation to case (M8)	20 Nm
Spark plug to cylinder head	25 Nm
Ignition harness to spark plug	10 Nm
Nut of valve clearance setscrew	15 Nm
Cover to fuel pump	2 Nm
Clamp to alternator (M6)	8 Nm
Clamp to alternator (M8)	20 Nm
Clamp to case (M8)	20 Nm
Alternator to case (M10)	45 Nm
Magneto to housing (M8)	20 Nm
Exhaust flange to cylinder head	20 Nm
Engine support to case (M10)	45 Nm *)
Stud bolt (M12) for engine suspension on crankcase	30 Nm **)
Grounding wire to magneto (Slick)	1,5 Nm

*) Not for L 1700 EA

***) Applies to L 1700 EA

Insert stud bolt with threadlocker P/N: 708.413.015.

Note: Torque specification of 30 Nm only valid for stud bolt,
NOT for the castle nut to be mounted on it!

12 Trouble Shooting

"Small", apparently neglectable causes are often responsible for a "big" effect, i.e. disturbance of engine operation. Detection of the causes is not always easy. The hints to possible trouble causes and their correction contained in this section serve as a guideline for the engine user, listing the most frequent faults. This list of causes, however, does not claim for completeness.

Repair work must be done only by persons authorized to perform the specific task.

12.1 Engine Starting Trouble

Possible Cause:	Remedy:
Battery discharged or defective.	Charge or replace battery.
Battery wiring not connected to starter motor or defective, possibly insufficient contact.	Clean connectors. Connect or replace ground wire.
Ground wire to engine not connected, defective, possibly insufficient contact.	Clean connectors. Connect or replace ground wire.
Starter motor defective.	Repair or replace starter motor.
Starter relay defective.	Replace starter relay.
Insufficient compression (no valve clearance, leaky valves, engine overheated).	Adjust valve clearance, repair cylinder head, tighten cylinder heads according to specification. Investigate and remove cause of overheat.
Engine defective (blocked or worn out).	Overhaul engine.
Ignition switched off.	Switch ignition.
Magneto defective.	Repair magneto.
Short circuit at capacitor connector, wiring or ignition switch.	Clear short circuit.
Magneto impulse coupling does not work.	Repair or replace impulse coupling, note assembly clearance.
Ignition harness disengaged, mixed up or damaged.	Fasten or replace ignition harness, Ignition sequence 1-3-2-4. Note marking of sleeve nuts.
Spark plugs wet due to excess fuel.	Remove spark plugs, clean and dry. Determine and eliminate cause of excess fuel.
Electrode gap of spark plug too wide.	Correct electrode gap to 0.4 to 0.5 mm or replace spark plugs.

Possible Cause:	Remedy:
Fuel tank empty (faulty indication of fuel gauge).	Refuel, replace fuel gauge.
Fuel valve closed or filter locked.	Open fuel valve, clean or replace filter.
Fuel line defective or not connected.	Replace or connect fuel line.
Fuel pump defective.	Repair or replace fuel pump.
Induction system leakage.	Check induction system for leakage and replace, if necessary, tighten joints.
Carburetor contaminated or locked.	Clean carburetor.
Choke not operated to its stop (cold engine).	Operate choke and check as necessary.

12.2 Engine Operating Trouble

The following phenomena are considered to be engine operating trouble:

- uneven and irregular engine run
- temporary interruptions
- low power
- engine overheat
- rough engine run

Consider reasons as per section 12.1 besides the ones listed below.

12.2.1 Fuel Supply

Possible Cause:	Remedy:
Insufficient fuel flow (Fuel ventilation locked, lines blocked or defective, filter or screens blocked).	Check tank ventilation, lines, filter and screens and replace as necessary.
Insufficient fuel pump pressure.	Check fuel pump pressure and correct, if necessary.
Fuel pump defective.	Repair or replace fuel pump.
Float valve contaminated, jammed or worn.	Clean or replace float valve.
Wrong carburetor float level.	Adjust float level.

Possible Cause:	Remedy:
Carburetor float defective.	Replace float.
Carburetor diaphragm defective.	Replace diaphragm.
Lack of damping oil in carburetor.	Refill damping oil.
Wrong idling speed.	Adjust idling speed.
Throttle does not open fully.	Repair throttle control.
Carburetors not synchronous (2-carburetor system).	Adjust carburetor setting.
Wrong installation of carburetor gasket (at air filter).	Replace gasket, consider notches.
Choke engaged at warm engine.	Disengage choke.
Choke defective (worn out).	Repair or replace choke.
Wrong mixture setting.	Check setting and operation of carburetor and correct as necessary.
Carburetor icing.	Operate carburetor heating system.
Induction air filter badly contaminated or blocked.	Clean or replace air filter.
Induction system leakage.	Seal or replace induction system.
Wrong fuel.	Refill fuel tank with specified fuel.

12.2.2 Ignition

Possible Cause:	Remedy:
Magneto defective.	Repair or replace magneto.
Wrong magneto timing.	Check and set magneto timing as necessary.
Ignition switch defective.	Check grounding wire and switch and replace as necessary.
Ignition harness loose or defective.	Fasten or replace harness.
Spark plug defective.	Replace spark plug.
Wrong spark plugs.	Use specified spark plugs.

12.2.3 Cooling

Possible Cause:	Remedy:
Insufficient or damaged baffling.	Repair or complete baffling. Seal leakages.
Carburetor shielding defective or missing (2 carburetors).	Replace carburetor shielding.
Cooling air inlet disturbance (missing spinner, cross section too small).	Install spinner, increase air inlets in cowling.
Fresh air and heating system ducts defective.	Replace ducts.
Cooling air outlet disturbance (Cross section too small or cowlfap does not open sufficiently).	Increase air outlet in cowling.

12.2.4 Lubrication

Possible Cause:	Remedy:
Bad engine oil quality.	Change oil. Use specified oil.
Oil screen blocked.	Remove and clean oil screen, check condition and replace, if necessary.
Oil temperature sensor or indicator defective.	Check temperature sensor and indicator and replace as necessary.
Lack of oil in the oil sump.	Check oil level and refill oil as necessary.
	 Note: If the engine was accidentally operated without engine oil after performing an oil change – expect severe engine damage. A teardown inspection and repair ist strongly recommended for safe operation.
Oil pump defective.	Repair or replace oil pump.
Oil pressure regulating piston or spring defective.	Replace regulating piston or spring.
Oil loss due to blocked crankcase ventilation.	Clean ventilation, replace and properly install breather line (no bucklings or contractions).

170.253.905.000

12.3 Mechanical System

Possible Cause:	Remedy:
No valve clearance.	Set valve clearance.
Leaking or sticking valve.	Repair cylinder head.
	<p>Note: In some cases, fuel tanks made out of composite materials have been proven to be incompatible with the fuel, thus causing the tank material to dissolve. In such cases, the complete fuel system must be cleaned or even be re placed.</p>
Strong accumulation of deposit in the combustion chamber.	Demount cylinder heads, remove deposits.
Propeller unbalance.	Balance propeller. Check propeller blade track.
Engine suspension defective.	Replace engine suspension.
Excessive gas leakage at the piston.	Repair engine.
Bearing defective.	Repair engine.
Engine defective.	Repair engine.